



**YFS
Spring tensioners**

Capacity 0.5 - 10.0 kg

**YFS-A
Spring tensioners
with ratchet locking device**

Capacity 2 - 10.0 kg

Spring tensioners are designed to retract the cable when no force is applied. An amount of downward force must be continually applied to keep the suspended object at its extended position.

The torque output of the rewind spring increases as the cable is extended, retracting the suspended object to the uppermost adjusted position when released.

Features

- Stamped steel construction, powder-coated housing
- Automatic drumlock according to DIN 15112
- Additional hanger for the attachment of secondary safety chains according to DIN 15112
- Rope guide made of wear-resistant nylon for reduced wear of rope and body
- Declaration of EC-conformity
- Adjustable cable stop to fix the spring tensioner in the desired position
- Series YFS-A with ratchet-locking device. Locks the out-retracting rope for unrestricted tool movement. This device can be switched ON/OFF, so the spring tensioner can be used with or without the ratchet-locking device.

Applications

Pneumatic power-tools, assembly tools, paint spraying guns, riveting machines, nut runners, grinding and polishing machines.



Adjustment of spring tension YFS-01/02
with central turning wheel and spring lever



Adjustment of spring tension YFS-03/04/05
with central shaft and spring lever

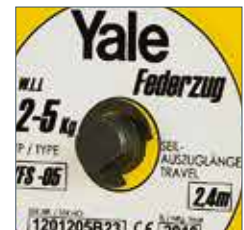

Technical data YFS and YFS-A

Model	Art.-No.	Capacity min. kg	Capacity max. kg	Working range m	Weight kg
YFS-01	N08300047	0.5	1.5	1.6	0.35
YFS-02	N08300048	1.5	3.0	1.5	0.35
YFS-03	N08300049	2.0	5.0	2.4	3.9
YFS-04	N08300050	4.0	6.0	2.4	4.5
YFS-05	N08300051	6.0	10.0	2.4	4.5
YFS-03-A	N08300052	2.0	5.0	2.4	3.9
YFS-04-A	N08300053	4.0	6.0	2.4	4.5
YFS-05-A	N08300054	6.0	10.0	2.4	4.5

Dimensions YFS and YFS-A

Model	YFS-01	YFS-02	YFS-03	YFS-04	YFS-05	YFS-03-A	YFS-04-A	YFS-05-A
A, mm	231	231	423	423	423	423	423	423
B, mm	224	224	214	214	214	214	214	214
C, mm	97	97	191	191	191	191	191	191
Ø D, mm	12	12	19	19	19	19	19	19
E, mm	48	48	79	79	79	91	91	91
F, mm	25	25	43	43	43	55	55	55
G, mm	-	-	71	71	71	71	71	71
H, mm	39	39	80	80	80	80	80	80

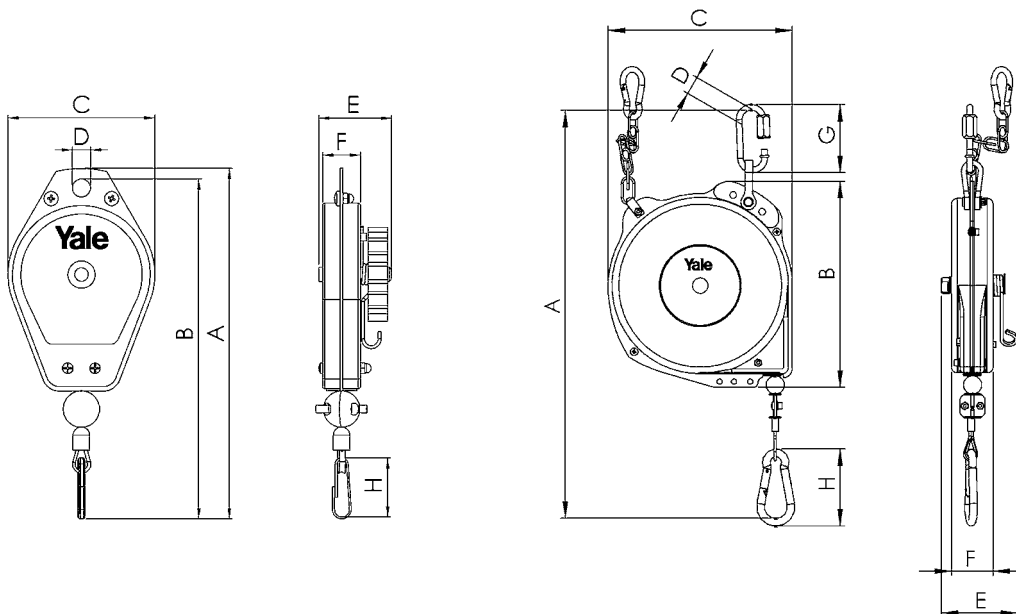

Spring Balancers



Load indicator

for:
YBF-09 - YBF-70
YBF-22L - YBF-70L
YBA-15 - YBA-70
YBA-22L - YBA-70L



Rope guide

for:
YBF-09 - YBF-200
YBF-09L - YBF-130L
YBA-15 - YBA-70



Spring assembly

as separate unit in a closed steel housing.
All models with capacities more than 5 kg.

YBF Spring balancers

Capacity 0.5 - 200 kg

YBF-L Spring balancers with extended rope length

Capacity 1.5 - 130 kg

Spring balancers are used to relieve the operator from the weight of hand-tools. By using a tapered rope drum the weight of the attached load is compensated, loads up to 200 kg can be moved effortlessly in vertical axis.

Features

- Spring balancers model YBF are designed in accordance with DIN 15112.
- The housing is manufactured from high-tensile aluminium pressure die casting for maximum resistance to impact.
- Manual drum lock for an easy exchange of rope or for changing the attached load.
- The special spring-assembly inside the balancer guarantees a consistent counterbalance throughout the complete working range.
- Easy exchange of wire rope. A small slot in the body facilitates the removal and re-installation of the rope without any need to disassemble the unit.
- Spring assemblies as separate units in a closed steel housing for improved handling during assembly and disassembly. Reduced risk of injuries.
- Rope guide made of wear-resistant nylon for reduced wear of rope and body. Lifetime of the spring balancer is increased. The rope guide can be removed and installed on site without disassembling the rope.
- Load indicator allows easy reading of the capacity set.
- Upper and lower suspension eyes are provided for the attachment of secondary safety chains. Providing additional safety and preventing the spring balancer and load from falling accidentally.

Applications

Spot-welding guns, riveting-machines, slaughterhouse equipment, multiple nut-runners etc.

Spring Balancers

YBA Spring balancers with safety feature in case of rope breakage

Capacity 9 - 70 kg

YBA-L Spring balancers with safety feature in case of rope breakage and with extended rope length

Capacity 9 - 70 kg

YBA series spring balancers have the same technical features as the YBF series, but are equipped with an additional safety feature in case of rope breakage.

This mechanism automatically locks the rope in case of accidental dislodging of the suspended weight, breakage of the bottom hook or the rope.

Whipping of the rope and potential injuries to the operator or other personnel in the area is avoided.

This series is used primarily in areas in which higher safety standards are applied or adverse conditions are common (flying sparks etc.) which might cause damages to the rope.

This series is available with standard and extended rope length.



Suspension eye

According to DIN 15112 spring balancers must be equipped with additional suspension eyes for the attachment of secondary safety chains.



Easy exchange of wire rope

Without any need to disassemble the unit.
YBF-09 - YBF-100
YBA-15 - YBA-70



Manual drum-lock

For an easy exchange of the rope.
All models with capacity more than 5 kg.

Spring Balancers

Technical data YBF and YBF-L

Model	Suspension eyes top (T) and bottom (B)	Adjustment of spring tension V=vertical H=horizontal	Tapered rope drum	Manual drum lock	Automatic drum-locking device	Load indicator	Spring assembly enclosed	Closed body	Rope guide, nylon	Rope exchange without disassembly
YBF-01	T	H	•	–	–	–	–	•	–	–
YBF-02	T	H	•	–	–	–	–	•	–	–
YBF-03	T	H	•	–	–	–	–	•	–	–
YBF-05	T	H	•	–	–	–	–	•	–	–
YBF-09	T	H	•	•	•	•	•	•	•	•
YBF-15	T	H	•	•	•	•	•	•	•	•
YBF-22	T + B	V	•	•	•	•	•	•	•	•
YBF-30	T + B	V	•	•	•	•	•	•	•	•
YBF-40	T + B	V	•	•	•	•	•	•	•	•
YBF-50	T + B	V	•	•	•	•	•	•	•	•
YBF-60	T + B	V	•	•	•	•	•	•	•	•
YBF-70	T + B	V	•	•	•	•	•	•	•	•
YBF-85	T + B	V	•	•	•	–	•	•	•	•
YBF-100	T + B	V	•	•	•	–	•	•	•	•
YBF-120	T	H	•	•	•	–	•	•	•	–
YBF-140	T	H	•	•	•	–	•	•	•	–
YBF-170	T	H	•	•	•	–	•	•	•	–
YBF-200	T	H	•	•	•	–	•	•	•	–
YBF-03L	T	H	•	–	•	–	–	•	–	–
YBF-05L	T	H	•	–	•	–	–	•	–	–
YBF-09L	T	V	•	•	•	–	•	•	•	–
YBF-15L	T	V	•	•	•	–	•	•	•	–
YBF-22L	T	V	•	•	•	•	•	•	•	–
YBF-30L	T	V	•	•	•	•	•	•	•	–
YBF-40L	T + B	V	•	•	•	•	•	•	•	–
YBF-50L	T + B	V	•	•	•	•	•	•	•	–
YBF-60L	T + B	V	•	•	•	•	•	•	•	–
YBF-70L	T + B	V	•	•	•	•	•	•	•	–
YBF-85L	T + B	V	•	•	•	–	•	•	•	–
YBF-100L	T	H	•	•	•	–	•	•	•	–
YBF-120L	T	H	•	•	•	–	•	•	•	–
YBF-130L	T	H	•	•	•	–	•	•	•	–

Technical data YBA and YBA-L

Model	Suspension eyes top (T) and bottom (B)	Adjustment of spring tension V=vertical H=horizontal	Tapered rope drum	Manual drum lock	Automatic drum-locking device	Load indicator	Spring assembly enclosed	Closed body	Rope guide, nylon	Rope exchange without disassembly
YBA-15	T	V	•	•	•	•	•	•	•	•
YBA-22	T + B	V	•	•	•	•	•	•	•	•
YBA-30	T + B	V	•	•	•	•	•	•	•	•
YBA-40	T + B	V	•	•	•	•	•	•	•	•
YBA-50	T + B	V	•	•	•	•	•	•	•	•
YBA-60	T + B	V	•	•	•	•	•	•	•	•
YBA-70	T + B	V	•	•	•	•	•	•	•	•
YBA-15L	T + B	V	•	•	•	–	•	•	•	–
YBA-22L	T + B	V	•	•	•	•	•	•	•	–
YBA-30L	T + B	V	•	•	•	•	•	•	•	–
YBA-40L	T + B	V	•	•	•	•	•	•	•	–
YBA-50L	T + B	V	•	•	•	•	•	•	•	–
YBA-60L	T + B	V	•	•	•	•	•	•	•	–
YBA-70L	T + B	V	•	•	•	•	•	•	•	–

Technical data YBF and YBF-L

Model	Art.-No.	Capacity min.	Capacity max.	Working range	Weight with rope
		kg	kg	m	kg
YBF-01	N08300001	0.5	1.5	1.0	1.0
YBF-02	N08300002	1	2	1.0	1.0
YBF-03	N08300003	1.5	3	1.3	1.8
YBF-05	N08300004	3	5	1.3	1.9
YBF-09	N08300007	4.5	9	1.3	4.0
YBF-15	N08300008	9	15	1.3	4.0
YBF-22	N08300009	15	22	1.5	8.0
YBF-30	N08300010	22	30	1.5	8.0
YBF-40	N08300011	30	40	1.5	10.5
YBF-50	N08300012	40	50	1.5	10.5
YBF-60	N08300013	50	60	1.5	11.0
YBF-70	N08300014	60	70	1.5	11.5
YBF-85	N08300015	70	85	1.5	12.0
YBF-100	N08300016	85	100	1.5	12.5
YBF-120	N08300017	100	120	1.5	28.0
YBF-140	N08300018	120	140	1.5	29.0
YBF-170	N08300019	140	170	1.5	35.0
YBF-200	N08300020	170	200	1.5	36.0
YBF-03L	N08300005	1.5	3	2.5	3.9
YBF-05L	N08300006	3	5	2.5	4.0
YBF-09L	N08300021	4.5	9	2.3	7.0
YBF-15L	N08300022	9	15	2.3	7.5
YBF-22L	N08300023	15	22	2.3	8.5
YBF-30L	N08300024	22	30	2.3	8.5
YBF-40L	N08300025	30	40	2.3	11.0
YBF-50L	N08300026	40	50	2.3	11.0
YBF-60L	N08300027	50	60	2.3	11.5
YBF-70L	N08300028	60	70	2.3	12.0
YBF-85L	N08300029	70	85	2.5	26.5
YBF-100L	N08300030	85	100	2.5	27.0
YBF-120L	N08300031	100	120	2.5	34.0
YBF-130L	N08300032	120	130	2.5	35.0



Technical data YBA and YBA-L

Model	Art.-No.	Capacity min.	Capacity max.	Working range	Weight with rope
		kg	kg	m	kg
YBA-15	N08300033	9	15	1.3	5.5
YBA-22	N08300034	15	22	1.5	8.5
YBA-30	N08300035	22	30	1.5	9.0
YBA-40	N08300036	30	40	1.5	11.5
YBA-50	N08300037	40	50	1.5	12.0
YBA-60	N08300038	50	60	1.5	13.0
YBA-70	N08300039	60	70	1.5	13.5
YBA-15L	N08300040	9	15	2.3	8.5
YBA-22L	N08300041	15	22	2.3	9.0
YBA-30L	N08300042	22	30	2.3	9.5
YBA-40L	N08300043	30	40	2.3	12.0
YBA-50L	N08300044	40	50	2.3	12.5
YBA-60L	N08300045	50	60	2.3	13.5
YBA-70L	N08300046	60	70	2.3	14.0

Spring Balancers

Dimensions spring balancers body type I, body type II & body type III

Model	Body type I		Body type II			Body type III					
	YBF-01 YBF-02	YBF-03 YBF-05	YBF-09 YBF-15	YBF-03L YBF-05L	YBA-15	YBF-22 YBF-30	YBF-40 YBF-50	YBF-60 YBF-70 YBF-85 YBF-100	YBF-09L YBF-15L YBF-22L YBF-30L	YBF-40L YBF-50L	YBF-60L YBF-70L
A min., mm	315	290	340	375	340	445	440	440	445	440	440
A max., mm	1315	1590	1640	2875	1640	1945	1940	1940	2745	2740	2740
B, mm	132	148	174	197	174	218	220	220	218	220	220
C, mm	72	89	109	114	109	130	130	130	130	130	130
D, mm	68	78	95	105	95	111	111	111	111	111	111
E, mm	120	120	152	175	152	194	194	194	194	194	194
F, mm	22	25	15	23	15	35	35	35	35	35	35
G, mm	26	33	38	30	38	47	47	47	47	47	47
H, mm	10	10	12	12	12	15	17	17	15	17	17
I, mm	14	14	24	14	24	30	30	30	30	30	30
J, mm	9	9	14	14	14	18	18	18	18	18	18
K, mm	10	8	15	14	15	18	18	18	18	18	18
L, mm	17	14	18	17	18	24	24	24	24	24	24
M min., mm	45	45	39	65	39	46	46	46	46	46	46
M max., mm	65	75	68	105	68	83	83	83	83	83	83
N, mm	9	9	14	14	14	16	16	16	16	16	16
O, mm	6	6	9	8	9	12	14	14	12	14	14
P, mm	11	12	24	30	24	35	75	86	35	75	86
Q, mm	5	9	25	9	25	30	33	33	30	33	33
R, mm	30	32	72	45	94	80	105	116	80	105	116
S min., mm	20	35	65	55	87	72	97	97	72	97	97
S max., mm	38	50	99	85	121	112	137	137	112	137	137
T, mm	49	69	136	110	148	158	188	199	158	188	199
U, mm	-	-	-	-	-	130	130	130	130	130	130

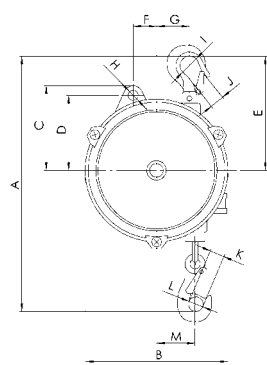

Body type I

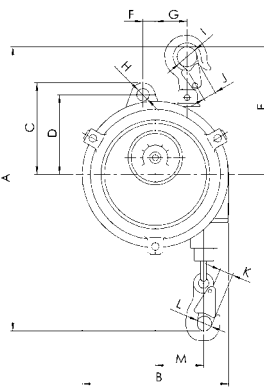
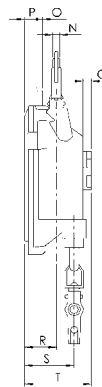

Body type II

Dimensions spring balancers body type IV & body type V

Model	Body type IV				Body type V					
	YBF-120 YBF-140	YBF-170 YBF-200	YBF-85L YBF-100L	YBF-120L YBF-130L	YBA-22 YBA-30	YBA-40 YBA-50	YBA-60 YBA-70	YBA-15L YBA-22L YBA-30L	YBA-40L YBA-50L	YBA-60L YBA-70L
A min., mm	550	550	550	550	445	440	440	445	440	440
A max., mm	2050	2050	3050	3050	1945	1940	1940	2745	2740	2740
B, mm	247	247	247	247	218	220	220	218	220	220
C, mm	156	156	156	156	130	130	130	130	130	130
D, mm	128	128	128	128	111	111	111	111	111	111
E, mm	265	265	265	265	194	194	194	194	194	194
F, mm	40	40	40	40	35	35	35	35	35	35
G, mm	65	65	65	65	47	47	47	47	47	47
H, mm	17	17	17	17	15	17	17	15	17	17
I, mm	26	26	26	26	30	30	30	30	30	30
J, mm	15	15	15	15	18	18	18	18	18	18
K, mm	24	24	24	24	18	18	18	18	18	18
L, mm	27	27	27	27	24	24	24	24	24	24
M min., mm	54	54	54	54	46	46	46	46	46	46
M max., mm	95	95	95	95	83	83	83	83	83	83
N, mm	18	18	18	18	16	16	16	16	16	16
O, mm	16	16	16	16	12	14	14	12	14	14
P, mm	142	185	142	185	55	95	105	55	95	105
Q, mm	37	37	37	37	30	33	33	30	33	33
R, mm	155	193	155	193	115	140	140	115	140	140
S min., mm	175	215	175	215	107	132	132	107	132	132
S max., mm	205	248	205	248	147	172	172	147	172	172
T, mm	268	268	268	310	180	208	218	180	208	218
U, mm	156	156	156	156	130	130	130	130	130	130

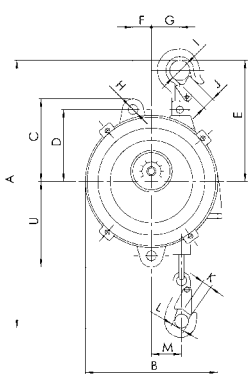

Body type III
Body type V

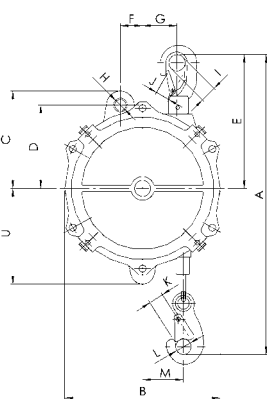
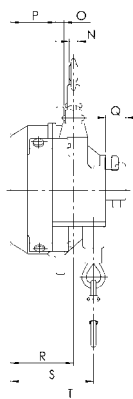

Body type IV

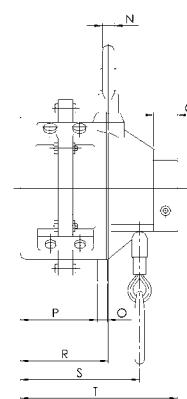

INFO

Yale hoists and trolleys are not designed for passenger elevation applications and must not be used for this purpose.